

LED NEON FLEX

NSR2-6 Slim LED Neon Flex

Features

- Dot-free linear neon-like illumination.
- High quality circuit for stable and reliable performance
- Color LED with color surface and white LED with color surface available.
- Side bending and small size for easy modeling
- Cutting mark by every 10.4mm.
- 5 year warranty

Specification

Item Code	Colour	CCT(K)/Wavelength	Luminous Flux(lm)	Efficacy(lm/W)
SA 66681	Pure white	6,500	284	24.65
SA 66682	Warm white	3,000	284	24.65
SA 66683	Red	620-625	36	3.13
SA 66684	Blue	465-470	39	3.34
SA 66686	Green	520-525	138	11.97
SA 66687	Yellow	587-589.5	62	5.38
SA 6668F	Light Yellow	587-589.5	62	5.38
SA 6668G	Orange	600-605	66	5.72
SA 6668R	Deep pink	1,600-1,700	70.33	6.10



Technical Characteristics

Power Consumption	11.52W/M
Voltage	DC12V
Current Dissipation	0.96A
Viewing Angle	139°
IP Rating	IP67
CRI (Ra)	80+
Dimmable	Dimmable

Dimensions (mm)



LED Type	2835 LED
LED Quantity	96 pcs/M
Cutable Length	10.4mm

Temperature Ranges

Operating temperature	-20~60°
Storage temperature	-20~70°

Warranty

Warranty	5 Years
----------	---------

Physical Characteristics

Dimensions(L*W*H)	5000*8*15mm
Weight	896g

Profile Drawings

Sectional View

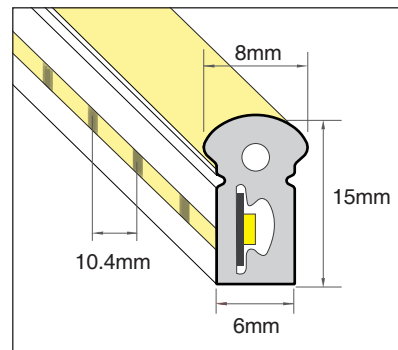

Minimum Bending Diameter

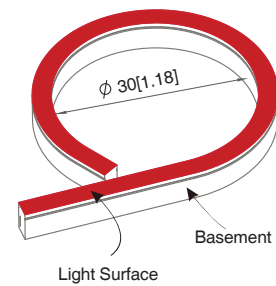

Double end feed

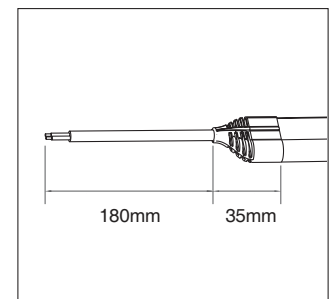
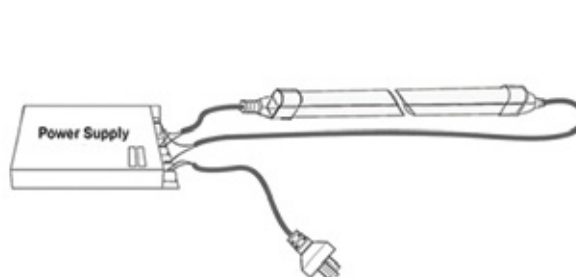

| Essential accessories

END CAP

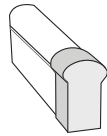

Without Hole
SA 9586

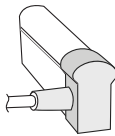

Right Hole
SA 9584

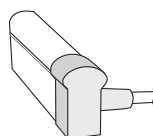

Left Hole
SA 9583

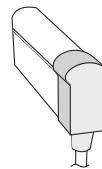

Bottom Hole
SA 9585

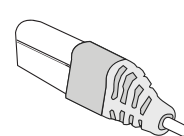

Straight Hole
SA 9582

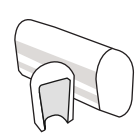

Coloured End Caps
SA 9580 ~ SA 9589

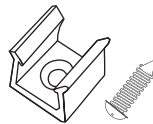

Clear Mount 10mm
SA 9586

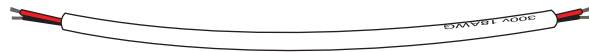

White Jacket Cable
SA 9581

| Essential tools



Neon cutter
SA 947



Super Glue_4ml
SA 9484